

SL-T2528RGBIC-L110

DATA SHEET

SPEC.NO. : SZ18092602
DATE : 2018/09/26
REV. : A/0

Approved By:

Checked By:

Prepared By:



% '

& '

' '

(..... ('

)  F "

LIGHT ELECTRONICS CO., LTD.

*" D] b Zi bVh] cb

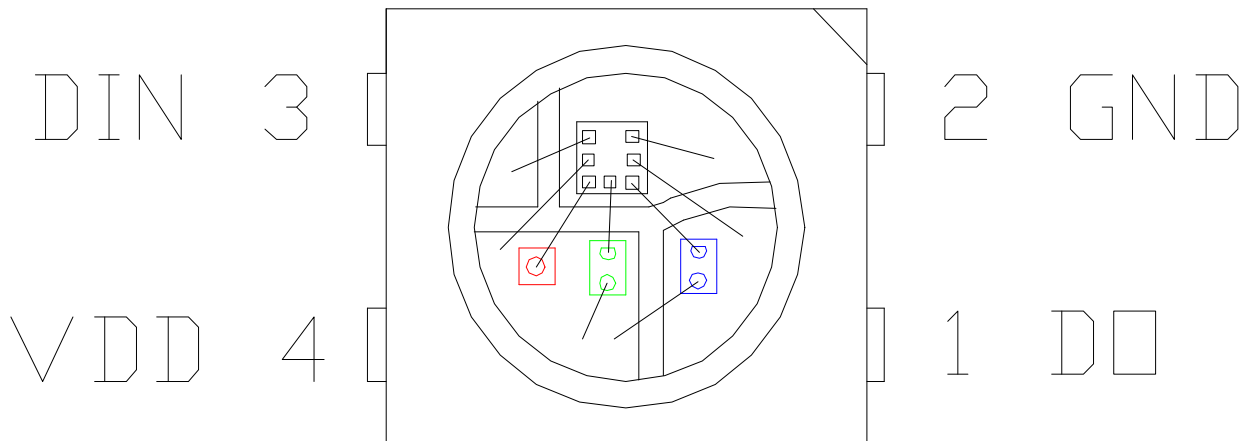

%	8C		
&	; B8		
'	8=B		
(J88		D76

+ " 9` YVhfc! cdh] WU` VXUFUVhYf] gh] Vg Uh HU1&) F; 6

=hYa	GraVc`	A]I	Hrd	AUI	I b] h	7cbX] h] cbg
8ca] bUbh kUj Y` Yb[h\	E` X	;)&\$)&)	ba	=: 1%&a5
		F *&\$		*&)		
		6 (*)		(+\$		
@ a] bci g] bhYbg] hm	=J	; , \$\$		%&\$\$	aVK	=: 1%&a5
		F &\$\$		(\$\$		
		6 % \$		' \$\$		

L

LIGHT ELECTRONICS CO., LTD.

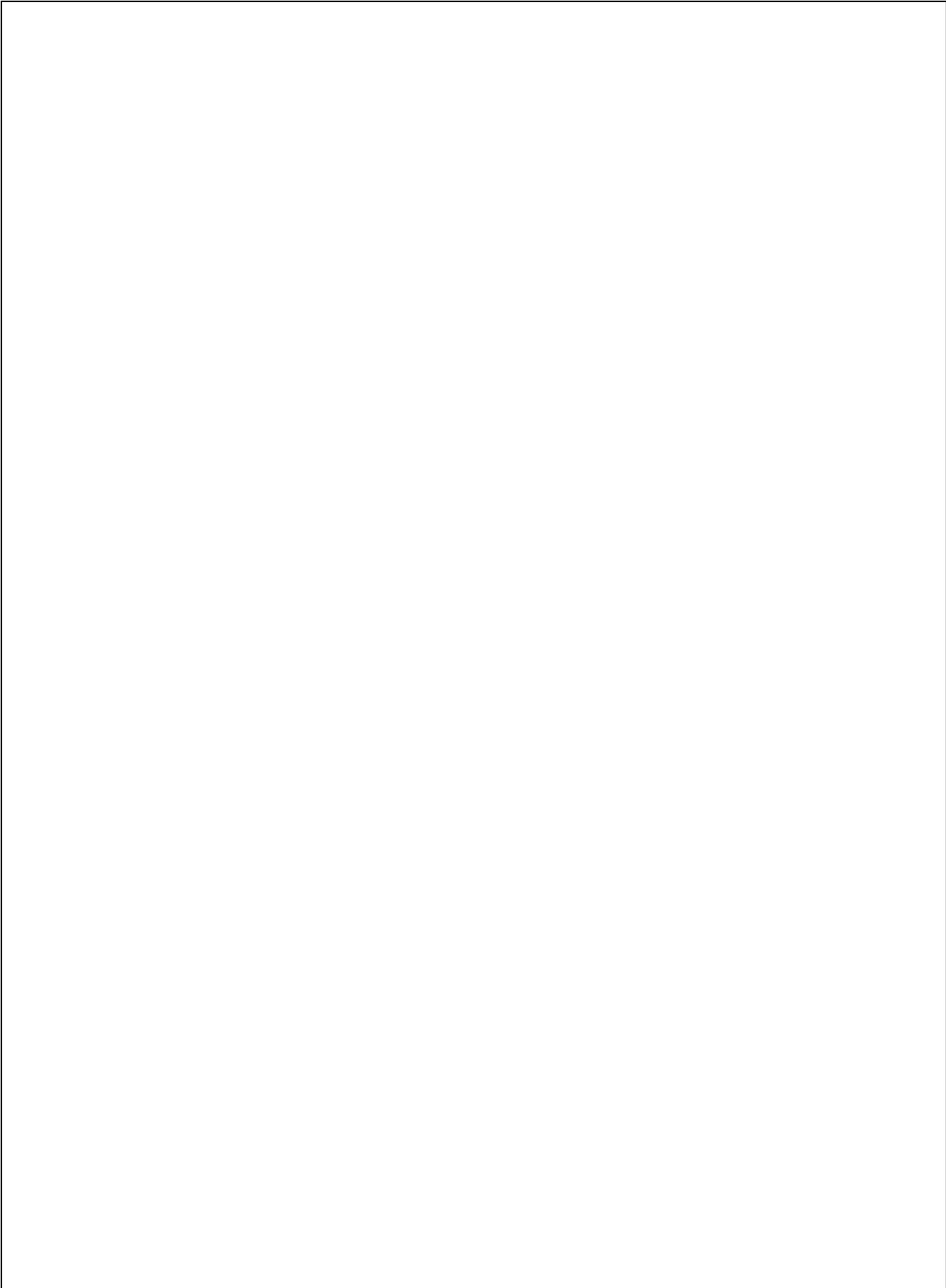

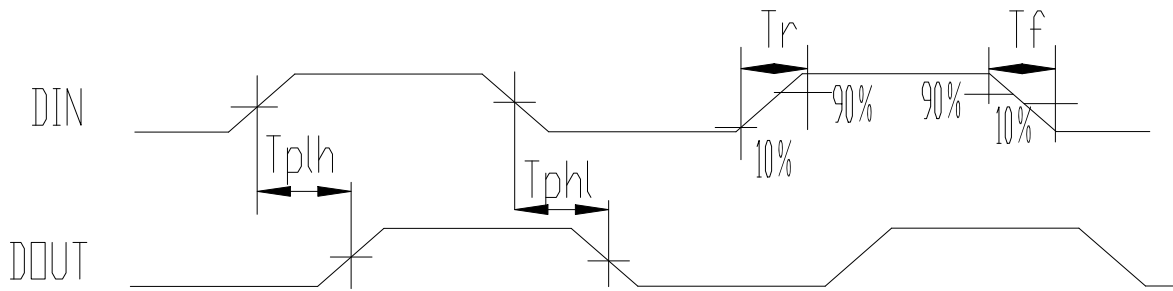

Symbolic representation of the timing diagram above.

Timing Parameters						
H	Symbol	Unit	Condition	Test Method	Notes	
HC<	\$	ns	&()	&-)	'()	bg
HC@	\$	ns)())-)	*()	bg
H%<	%	ns)())-)	*()	bg
H%@	%	ns	&()	&-)	'()	bg
Hfgh	FYgYh	ns	, \$!!	!!	i g

Symbolic representation of the timing diagram above.

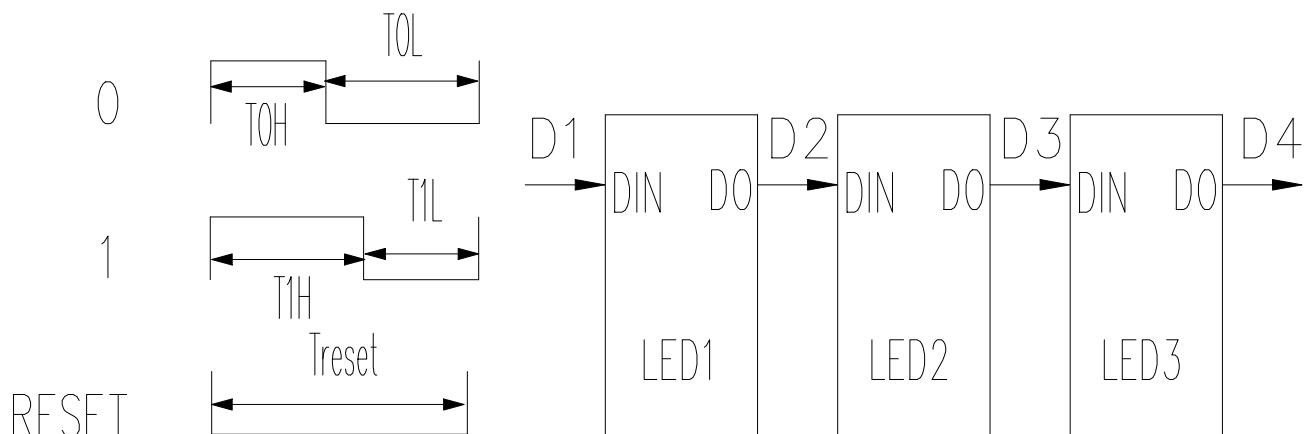

LIGHT

ID

Y cZ XUhU hfUbg

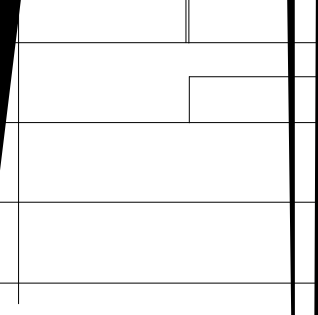

数据刷新

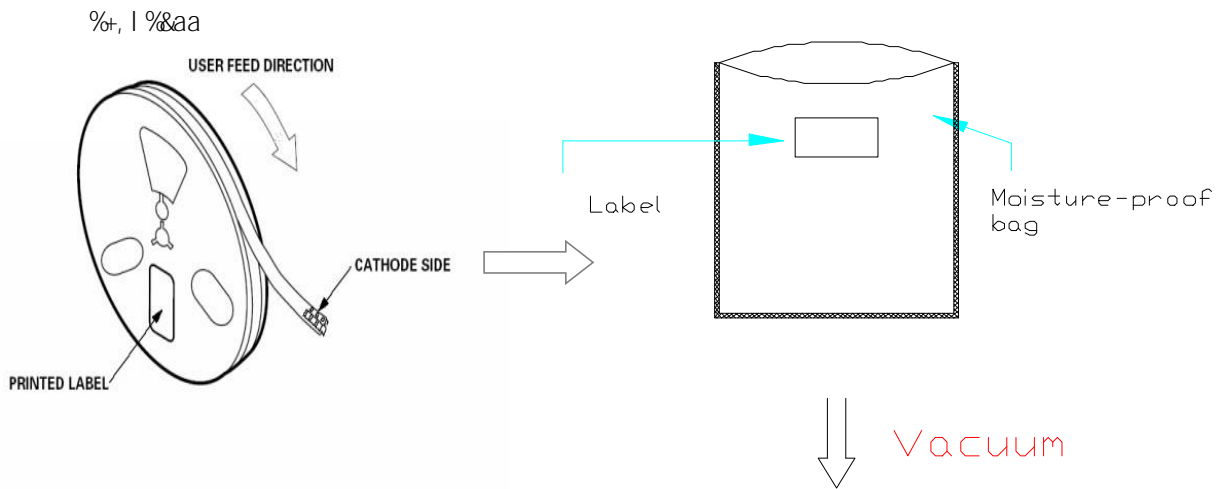
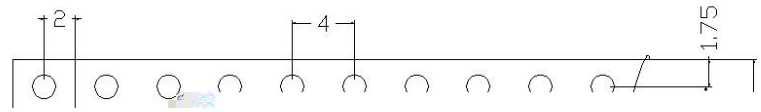

%" DUW_U[] b[GdYV\ Z] W[h] cbg

: YXX] b[8] fYVh] cb



LIGHT	
Light Electronics CO., LTD.	
MODEL NAME: _____	 LOT NO.: _____
QUANTITY: _____	
BIN: _____	
PACKING DATE: _____	
CUSTOMER P/N: _____	

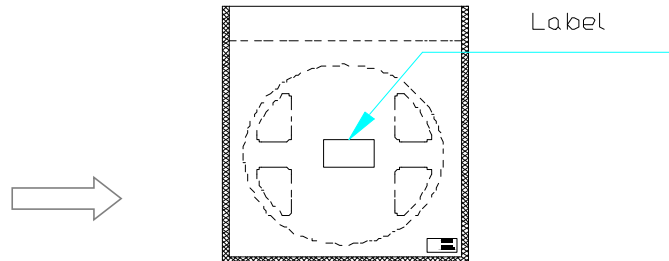

BchY. jc`iaY]g &\$\$\$dVg/

&\$\$\$dVg

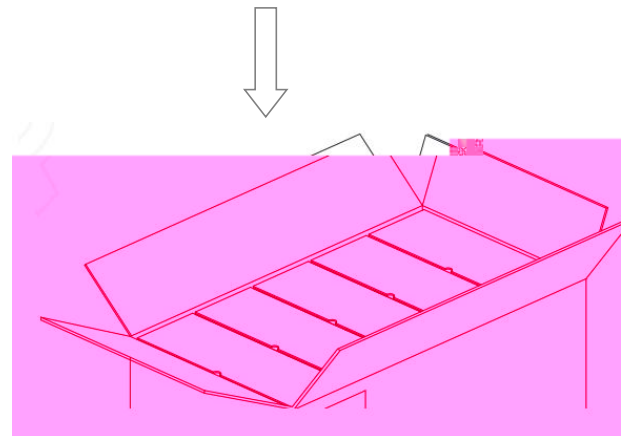



% " FY`]U]`]hm

H9GH =H9AG 5B8 F9GI @HG

	HYgh =hYa	FYZ" GhUbXUfX	HYgh 7cbX] h] cbg	BchY	7cbWi g] cb
%	FYZ` ck Gc` XYf] b[>9G8&&! 6%\$*	Hg` X1&(\$ ž%\$gYW	' h] aYg	\$#&&
&	HYadYfUhi fY 7mWY	>9G8&&! 5%\$(! &\$ ' \$a] b %&\$ ' \$a] b	&\$ \$ WmWY	\$#&&
,	HYfaU` G\cW_	>9G8&&! 5%\$*	! (\$ %&a] b %&) %&a] b	&\$ \$ WmWY	\$#&&
(<][\ HYadYfUhi fY GhcfU[Y	>9G8&&! 5%\$'	H,1%\$\$	%\$\$\$ \fg	\$#&&
)	@ck HYadYfUhi fY GhcfU[Y	>9G8&&! 5%%	H,1! (\$	%\$\$\$ \fg	\$#&&
*	DckYf hYadYfUhi fY 7mW] b[>9G8&&! 5%\$)	Cb) a] b! (\$ 2%&a] b 0%&a] b CZZ) a] b%\$\$ 2%&a] b	&\$ \$ WmWY	\$#&&
+	@]ZY HYgh	>9G8&&! 5%\$,	H,1&) = 1%&a5	%\$\$\$ \fg	\$#&&
,	<][\ <i a] X] hm <YUh @]ZY HYgh	>9G8&&! 5%\$%	*\$ F<1- \$i = 1%&a5	%\$\$\$ \fg	\$#&&

% " FYZ` ck dfcZ] `Y

GAB FYZ` ck Gc` XYf] b[=bghfi W] cbg

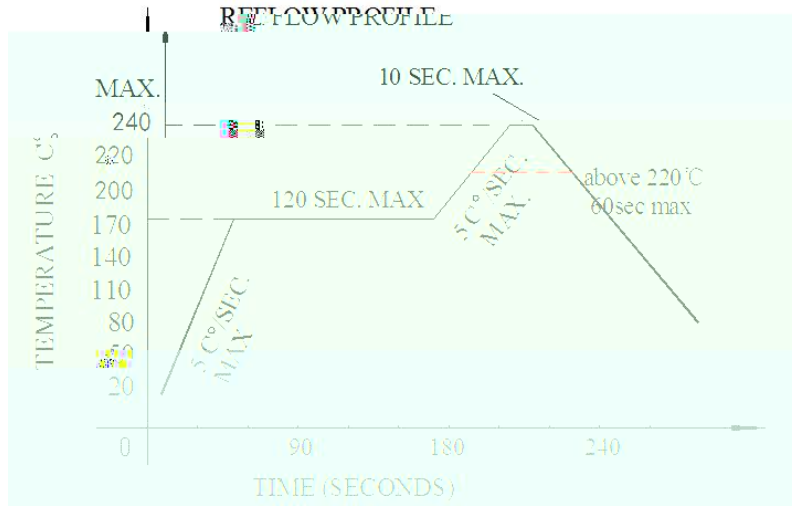

U" FYZ` ck gc` XYf] b[g\ci `X bch VY XcbY acfY h\Ub hkc h]aYg

&

V" K\Yb gc` XYf] b[žXc bch di h ghfYgg cb h\Y @98g Xi f] b[\YUh] b[

@98

Gc` XYf] b[] fcb

U" K\Yb \UbX gc` XYf] b[ž _YYd h\Y hYadYfUhi fY cZ h\Y] fcb i bXYf ' \$\$ ž UbX Uh h\Uh

hYadYfUhi fY _YYd h\Y h] aY i bXYf ' gYW

' \$\$

V" H\Y \UbX gc` XYf] b[g\ci `X VY XcbY cb` m U h] aY

FYkcf_

U" 7i ghcaYf ai gh Z] b] g\ fYkcf_ k] h\] b) gYWi bXYf &(\$

&(\$)

V" H\Y \YUX cZ] fcb WUb bch hci WX h\Y @98g

@98

W Hk] b! \YUX hmdY] g dfZYffYX"

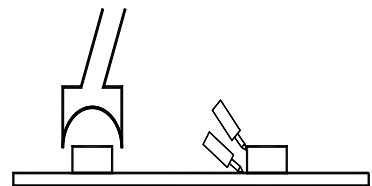



&\$" 75I H=CBC

BchY Zcf i a

=b cfXYf hc gi fY h\Uh =7 `Uad /UXg UfY i g `k]b GA! aUhWk fYZ` ck kY` X] UbX]b
h\Y i gY cZ h\Y dfcWrgg . . x UbX g'wV]`]hmcZ h\Y d. cXi V . h\Y Zc` `ck]b[dfcW... fYg UfY
gdYW]Z] YX UZhyf aUbm hYghg.

=7 GAH

U Glad` Y Yj U i Uh] cb. 6YWi gY h\] g dfcXi Wk]g U Vi]` h!]b =7 dfcXi Wk h\Y cj YfU` dfcWgg
]g X] ZZYfYbh Zfca Wcbj Ybh] cbU F; 6 dfcXi Wkz gc h\Y WghcaYf g] XY bYYXg hc Wffm ci h
U` ! fci bX j Yf] Z] Wkh] cb Xi f] b[h\Y glad` Y Yj U i Uh] cb hc Ybgi fY h\Y aUhW] b[dYfZcfaUbW
cZ h\Y dfcXi Wk

=7 F; 6

V =bWca] b[aUhyf] U]bgdYWh] cb. Ybgi fY h\Y j UW i a dUW] b[]g]bhUWk UbX h\YfY]g bc
j UW i a `YU_U[Y" =Z h\YfY]g j UW i a `YU_U[Yz d` YUgY WkbZ] fa k\Yh\Yf h\Y fYZ` ck kY` X] b[]g
UWbcfaU " =Z]h]g UWbcfaU z d` YUgY fYhi fb hc h\Y ZUWkcfm Zcf \] [\! hYadYfUhi fY
XY\i a] X] Z] Wkh] cb"

W I gY. D` YUgY WkbZ] fa h\YY\



X AU] bhYbUbWV. aUhYf] U` g\ci ` X VY Wcad` YhYX k] h\] b (\ci fg UbX XcaYgh] WXYaUbX UZhYf
fYZ` ck gc` XYf] b[hYgh UbX fYdU] f h\Y ` Uad VYUXž gi V\ Ug acfY h\Ub (\ci fg bYYX hc fYdU] f
h\Y ` Uad d` UhY hYadYfUhi fY UVcj Y *) XY\i a] X] Z] WUh] cb %& \ci fg hc fYdU] f kcf_ž UbX
fYdU] f h\Y ` Uad VYUX U` gc ai gh W\ffmcb h\Y ` ck hYadYfUhi fY UVcj Y *) XY\i a] X] Z] WUh] cb
%& \ci fgž i gY dfc\] V] hYX] b h\Y dfcW\gg cZ aU] bhYbUbWV k] h\ hYadYfUhi fY cj Yf &(\$
\YUh] b[aUW\] bY fYdU] fž dfc\] V] h h\Y k\c` Y d` UhY d` UW\X] b h\Y \YUh] b[ghU[Y fYdU] fž
Zc` `ck h\Y df] bW\`d` Y cZ VUX k\] V\ fYhi fb k\] V\ aYUgi f] b["

((*) %& *) %& &(\$

Y KUfa dfcadh. h\Y k\c` Y dfcW\gg gdYW\U` Wcbg] XYfUh] cbg Zcf `] [\h VYUX VYZcfY i gY
j UW\i a dUW_] b[ž XY\i a] X] Z] WUh] cbž GAH d` UW\aybh h] aY UbX kcf_g\cd cZ hYadYfUhi fY UbX
\i a] X] hmWcbhfc` ž dfcXi W\ aU] bhYbUbWV ` Uad d` UhY] Z VUFY Uh fcca hYadYfUhi fY Ybj] fcbaybh
Zcf U` cb[h] aY bYYX hc XY\i a] X] Z] WUh] cbž `] [\h VcUFX UbX `] [\h VYUX `] [\h VYUXg Ug @98
Y` YW\hfc] WdfcXi W\gž bYYX hc dUm UhhYbh] cb hc ac] ghi fY] b gdf] b[UbX gi aaYfž Ui hi ab UbX
k] bhYf Ubh] ! ghUh] Wž dfcXi W\ ei U] hm] g YbhYf df] gYfig `] ZYž hc h\Y ei U] hmghf] j Yg Zcf h\Y
gi fj] j U ž hc h\Y ei U] hmghf] j Yg Zcf h\Y XYj Y` cdaYbh] g ci f Wcbg] ghYbh U] a" 5` gc] b cfXYf
hc Ybgi fY h\Y ei U] hmcZ h\Y W] Ybhž d` YUgY ghf] W\` m fYZYf hc h\Y UVcj Y fYW\aaYbXUh] cbg

@98

LIGHT

LIGHT ELECTRONICS CO., LTD.

