

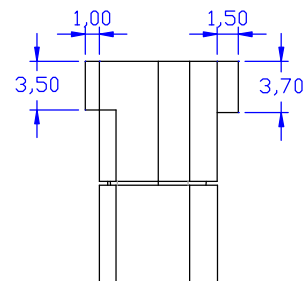

—
—
—

--	--	--	--

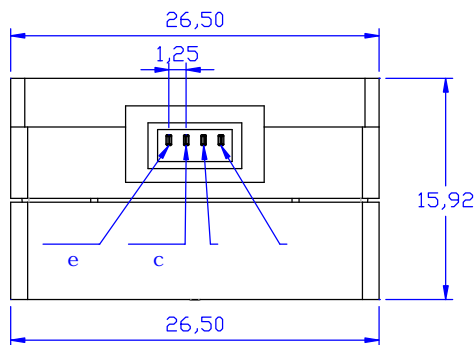
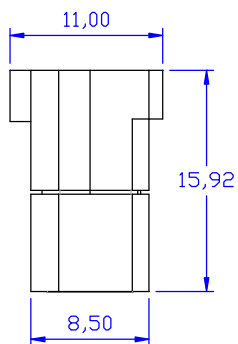
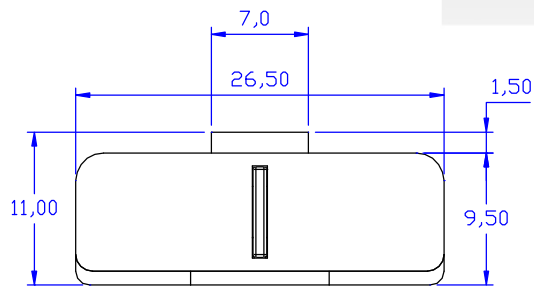
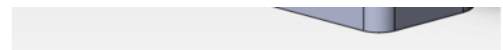
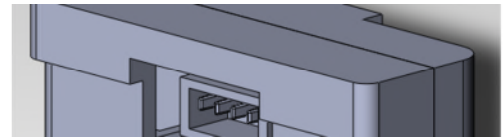

LI

LIGHT ELECTRONICS CO., LTD.

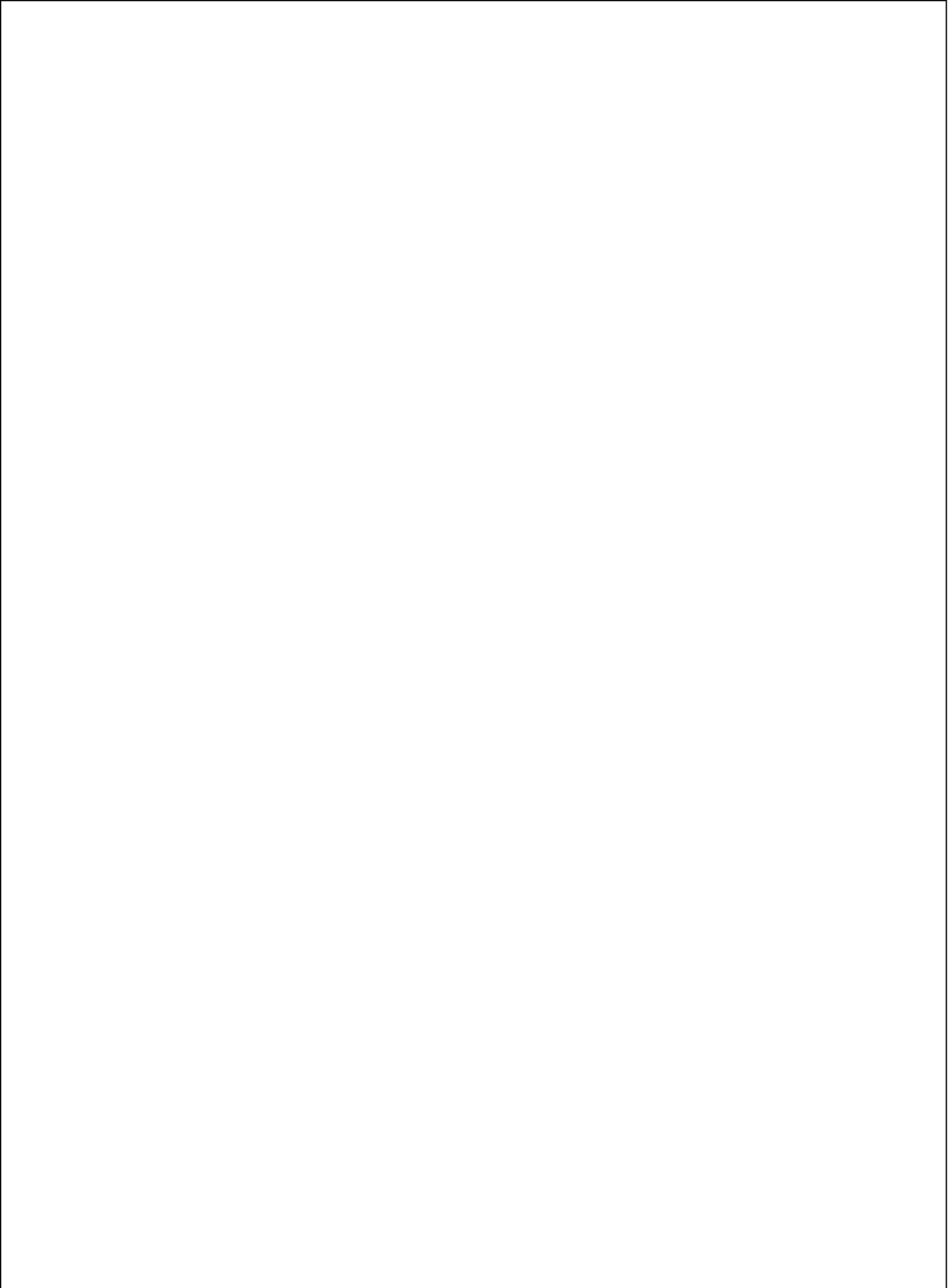

--	--	--	--

Peak Wavelength	p	---	940	---	nm	I

		---	15	---	μs	= 1K
		---	15	---	μs	