

LG-03PT4D94H-302C-B3

PHOTO TRANSISTOR

DATA SHEET

SPEC. NO. : SZ23022102
DATE : 2023/02/21
REV. : A/0

Approved By:

Checked By:

Prepared By:

Features

- ◆ Pb free product RoHS compliant
- ◆ High Photo Sensitivity
- ◆ General purpose leads
- ◆ Reliable and rugged
- ◆ Long life solid state reliability

Package Dimension

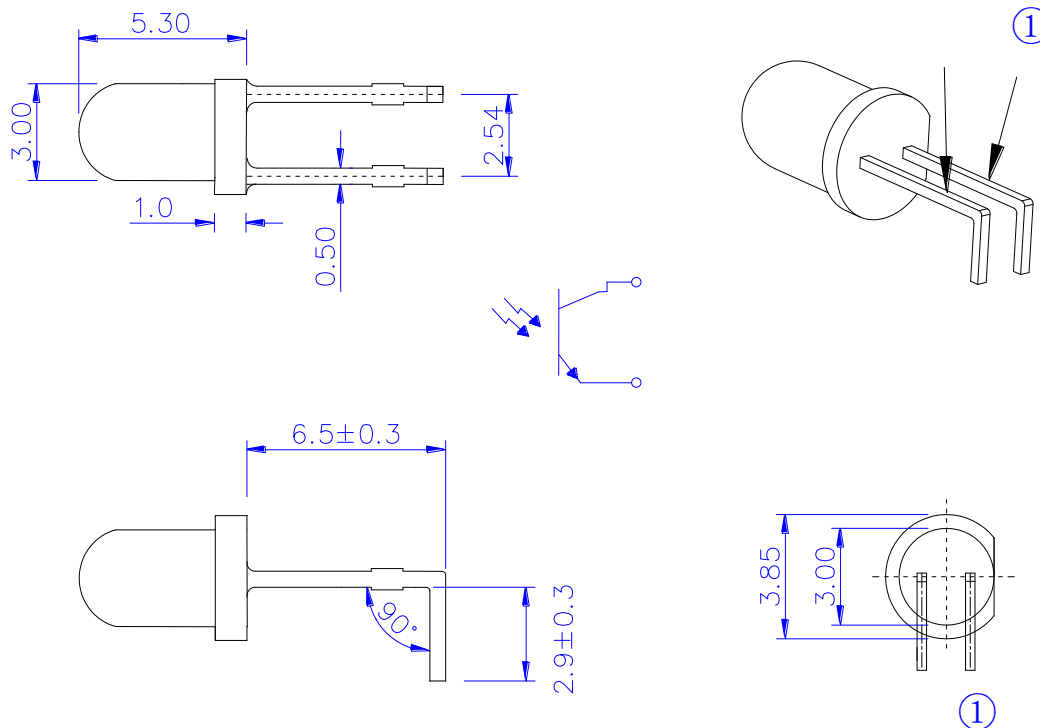

| Part NO. | Chip Material | Lens Color |
|----------------------|---------------|------------|
| LG-03PT4D94H-302C-B3 | Silicon | Black |

Notes:

1. All dimensions are in millimeters.
2. Tolerance is $\pm 0.20\text{mm}$ unless otherwise noted.
3. Protruded resin under flange is 1.0mm max.
4. Lead spacing is measured where the leads emerge from the package.

Absolute Maximum Ratings at Ta=25°C

1. Storage

The storage ambient for the LEDs should not exceed 30°C temperature or 70% relative humidity.

It is recommended that LEDs out of their original packaging are used within three months.

For extended storage out of their original packaging, it is recommended that the LEDs be stored in

Recommended Wave Soldering Profile

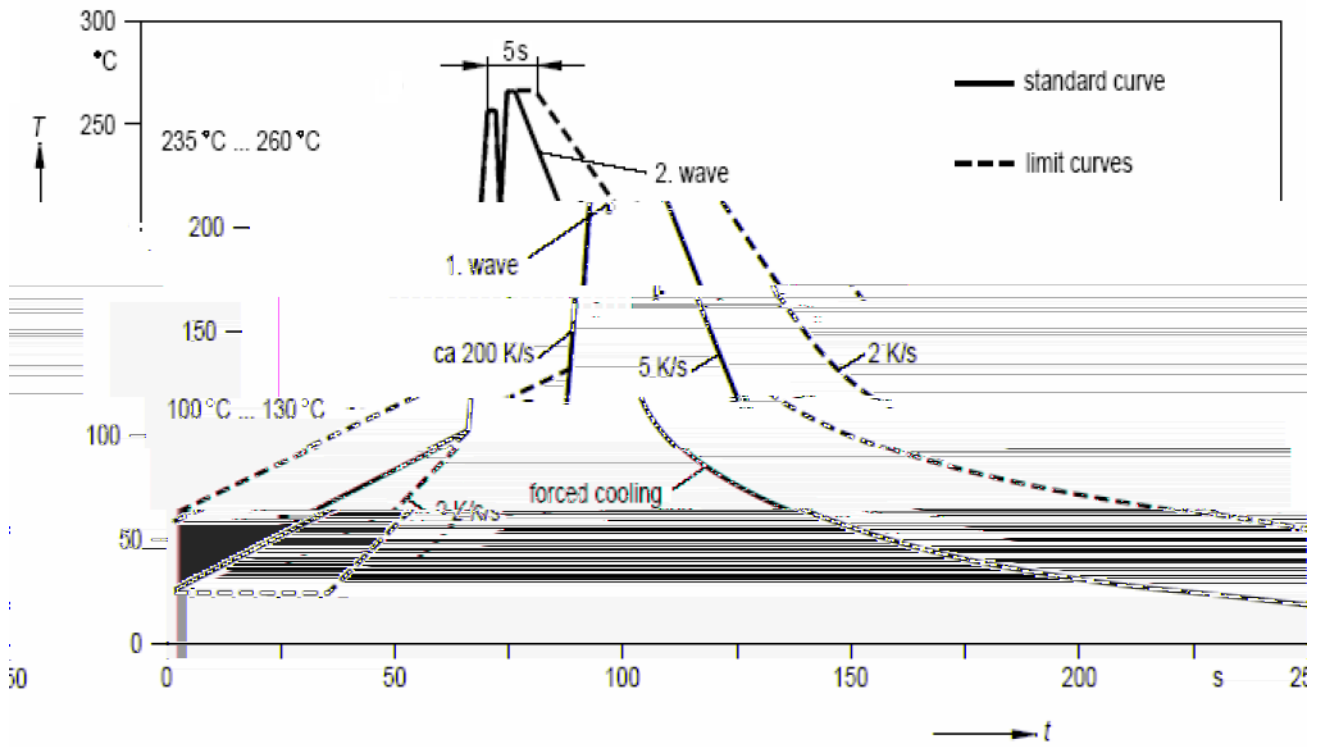

Typical Electrical / Optical Characteristics Curves (25°C Ambient Temperature Unless Otherwise Noted)

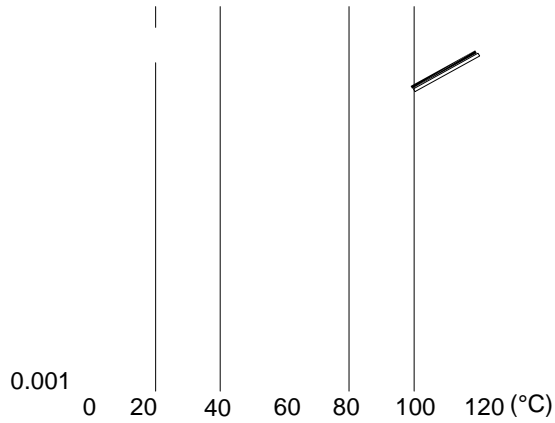

FIG.3 Rise And Fall Time Vs.

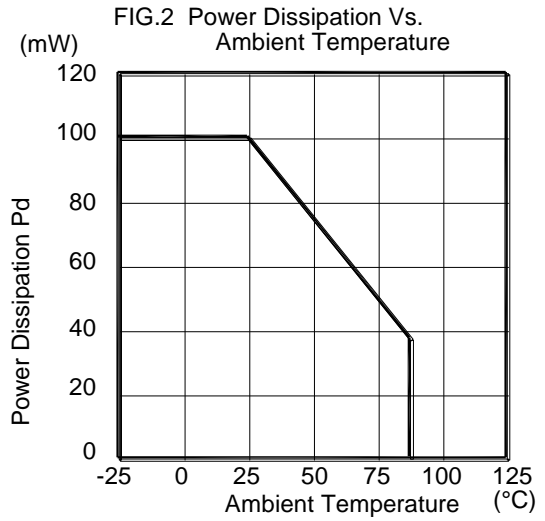
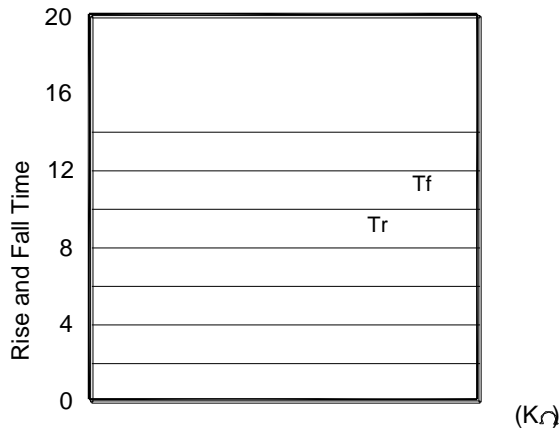

FIG.4 Relative Collector Current Vs. Irradiance

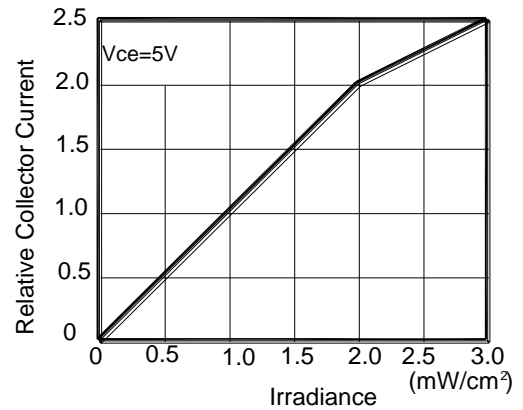

FIG.5 Light Current vs. Angular Displacement

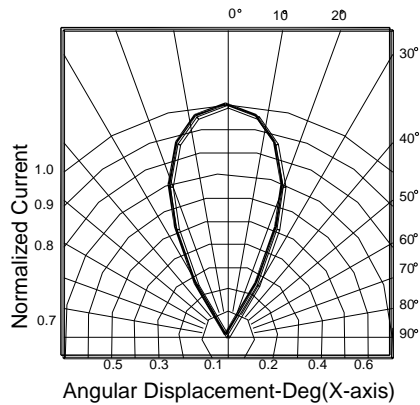
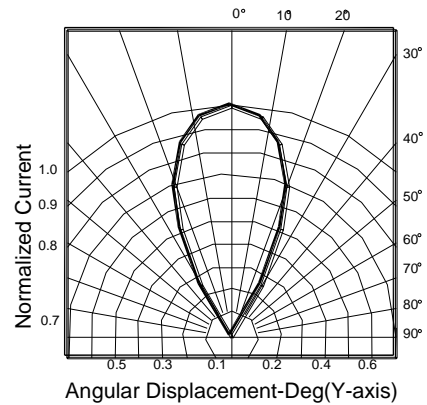
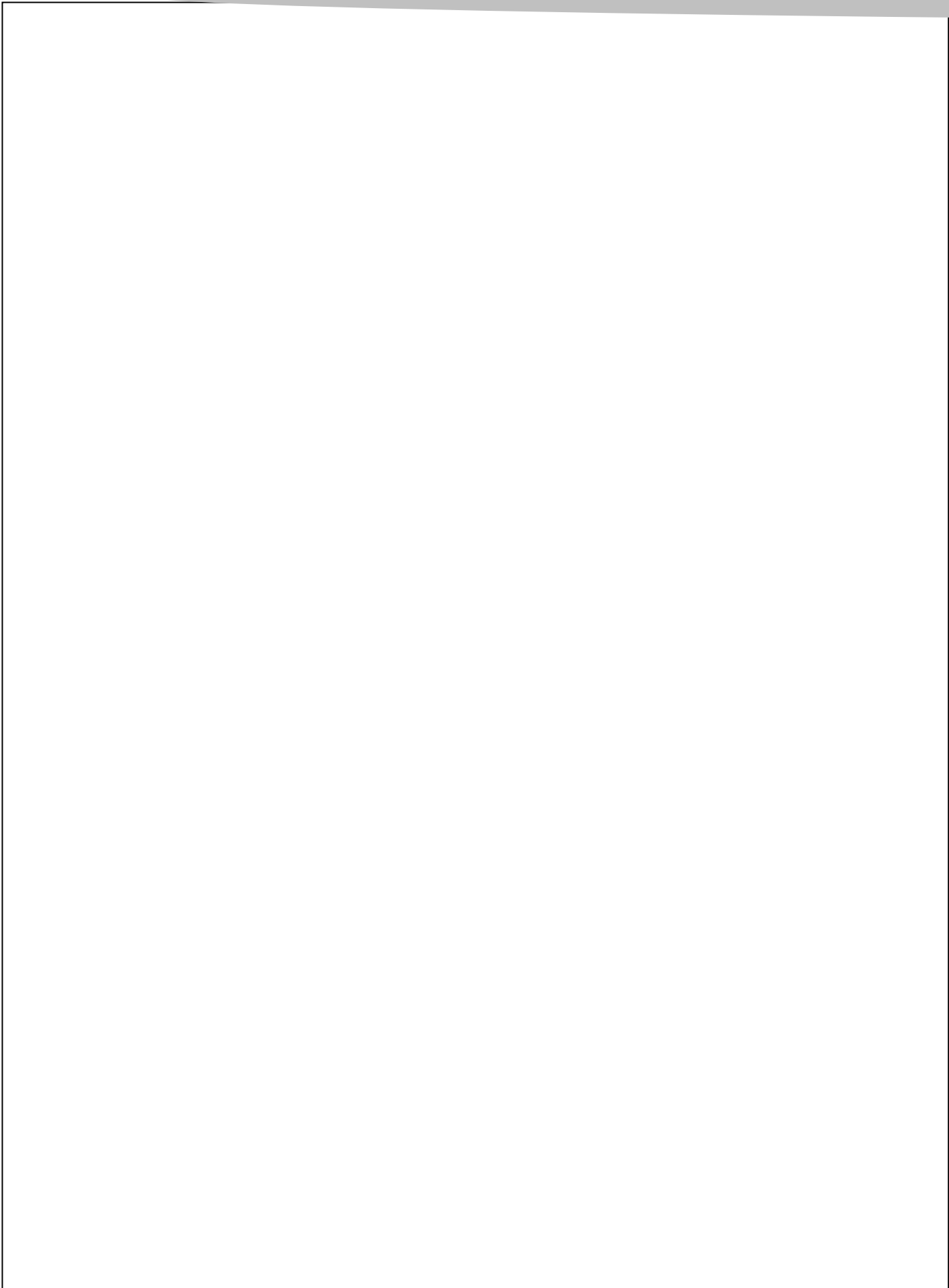

FIG.6 Light Current vs. Angular Displacement





LEAD FORMING PROCEDURES

1. Maintain a minimum of 2mm clearance between the base of the LED lens and the first lead bend (Fig.5 and Fig.6).

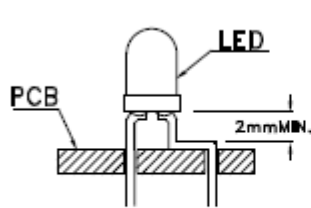

Fig. 5

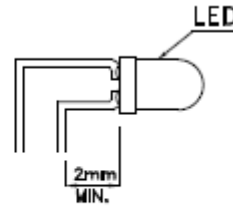

Fig. 6

2. Lead forming or bending must be performed before soldering, never during or after soldering.
3. Do not stress the LED lens during lead-forming in order to fractures in the lens epoxy and damage the internal structures.
4. During lead forming, use tools or jigs to hold the leads securely so that the bending force will not be transmitted to the LED lens and its internal structures. Do not perform lead forming once the component has been mounted onto the PCB (Fig.7).
5. Do not bend the leads more than twice (Fig.8).

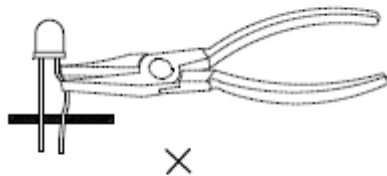

Fig. 7

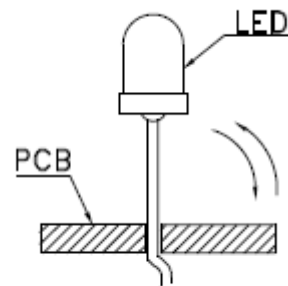

Fig. 8

6. After soldering or other high-temperature assembly, allow the LED to cool down to 50°C before applying outside force (Fig.9). In general, avoid placing excess force on the LED to avoid damage. For any questions please consult with LIGHT representative for proper handling procedures.

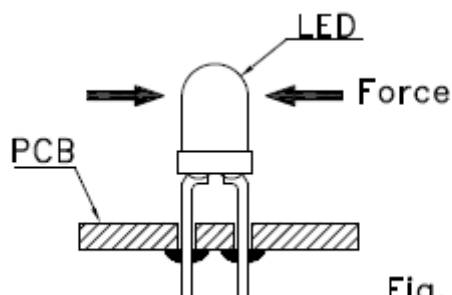
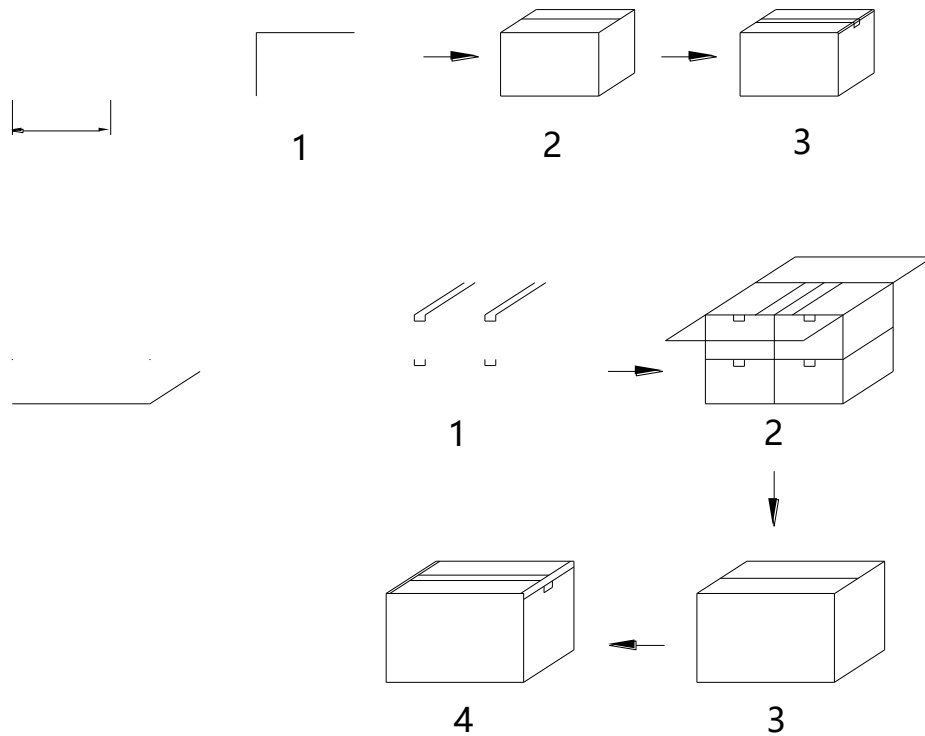
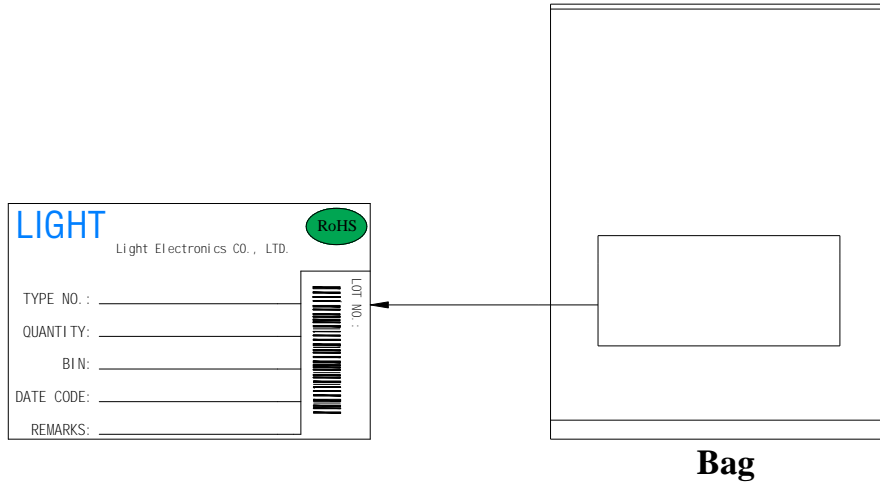

Fig. 9

PACKAGE



| Bag minimum volume (pcs / Bag) | Bag volume (pcs / Bag) | Inner box volume (Bag / box) | Outer carton volume (Box / Carton) |
|-----------------------------------|---------------------------|---------------------------------|---------------------------------------|
| 250 | 1000 | 10 | 4 |